

Light Indicator

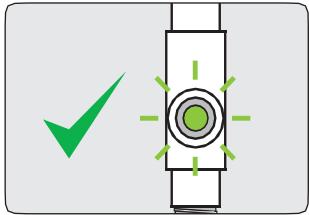

Green flashing light = Ready to dispense battery water.

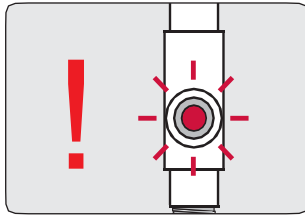

Consistent Red flashing light = Replace cartridge.

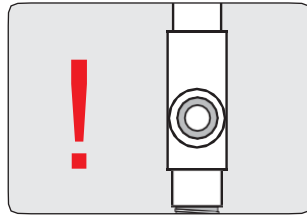

No light = Power problem. Check and/or replace batteries.

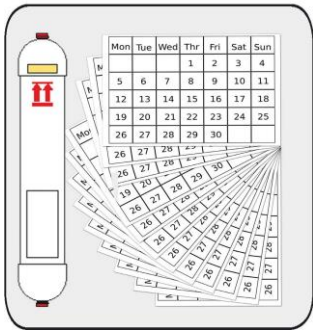

HydroPure Deionizer cartridges have a five-year shelf life from date of manufacture.

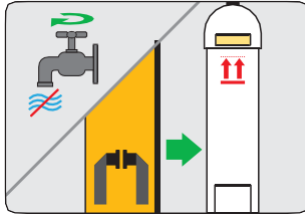

Ensure water supply is turned off and remove cartridge.

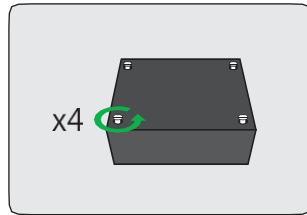

Remove the 4 screws from the battery case.

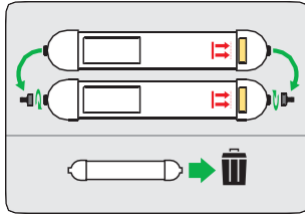

Transfer the 2 male quick-connect fittings to the new cartridge then safely dispose of the old cartridge.

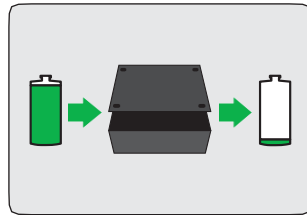

Remove the cover and replace the battery*.

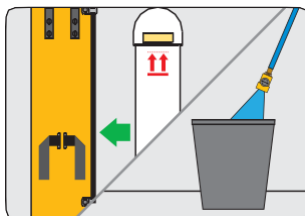

Install the new cartridge and allow from 5-10 gallons of water to flow through the cartridge, using either the Flow Restrictor or watering gun. This activates the resin that deionizes the water. The Purity Light will begin to flash green when enough water has passed through the cartridge.

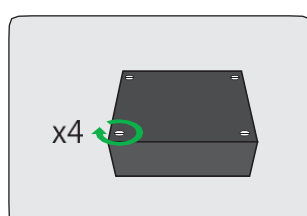

Replace the 4 screws in the battery casing.

*Please note that when the batteries are removed or changed a light function test is performed. The sequence of illumination is: (a) Red light single pulse, (b) Green light single pulse, (c) Red and Green lights together single pulse, (d) Return to normal flashing mode.



Philadelphia Scientific LLC
207 Progress Drive Montgomeryville, PA 18936
P: 215.616.0390 F: 215.616.0500 www.phlsci.com

HydroPure™ Deionizer System (PS-600)



Installation Instructions

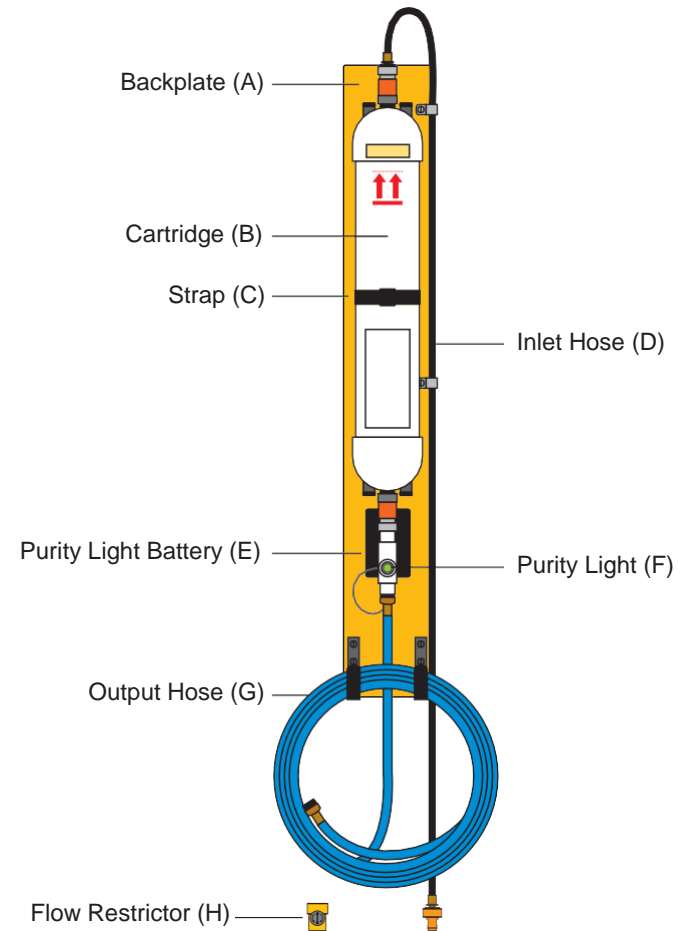

This pack contains:

- 1 x Backplate (A)
- 1 x Cartridge (B)
- 1 x Strap (C)
- 1 x Inlet Hose (D)
- 1 x Battery (E)
- 1 x Purity Light (F)
- 1 x Output Hose (G)
- 1 x Flow Restrictor (H)

Required:

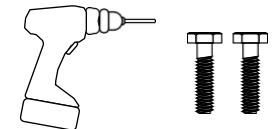



HEALTH AND SAFETY PRECAUTIONS
Batteries contain sulphuric acid, always wear approved protective clothing (gloves, goggles and apron).



Installation

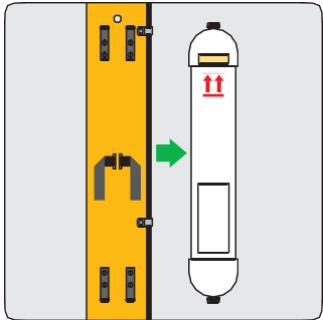

Remove cartridge from the mounting plate to ease installation.

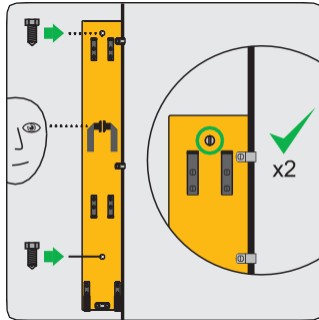

Securely attach the mounting plate vertically to the wall with the strap fitting at eye-level.

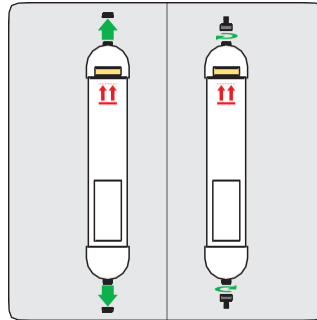

Remove the red caps from the cartridge and thread on the 2 male quick-connect fittings.

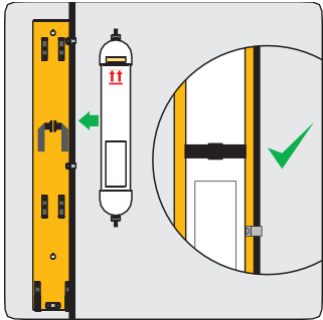

Re-attach the cartridge to the mounting plate using the strap. Ensure arrows are pointing up.

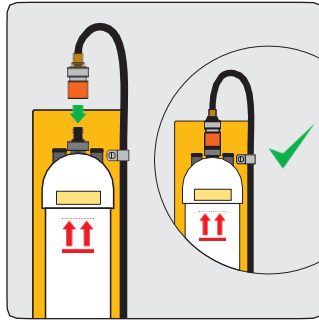

Connect the fixed end of the black inlet hose to the cartridge.

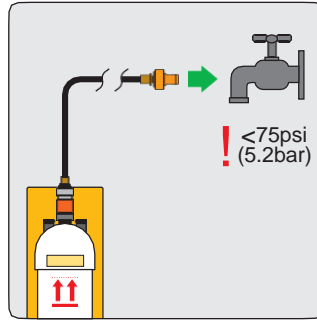

Connect the free end of the black inlet hose to the water supply.

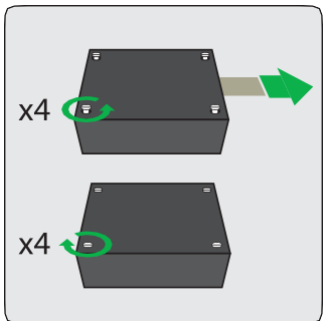

Loosen 4 screws of battery case and pull out tape to activate. Re-tighten screws.

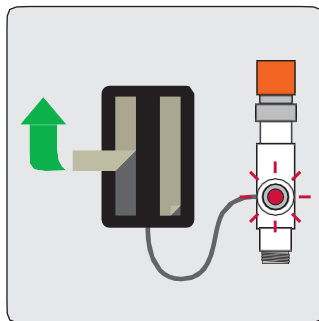

Remove backing tape from the velcro strips on the back of the battery case.

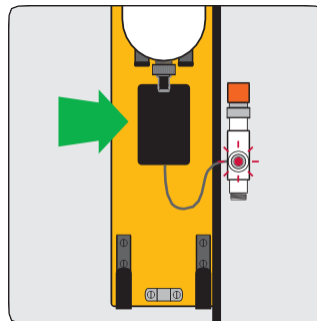

Attach the battery case firmly to the velcro strips on the backplate.

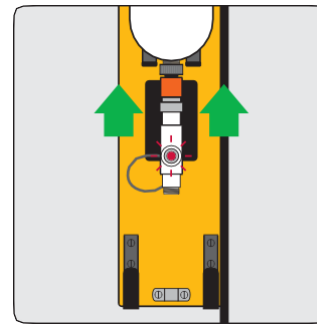

Using the quick-connect fitting attach the purity light to the bottom of the cartridge.

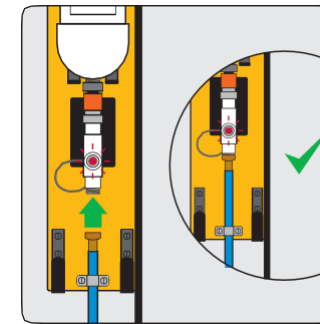

Attach the blue Output Hose to the purity light by using the threaded connection.

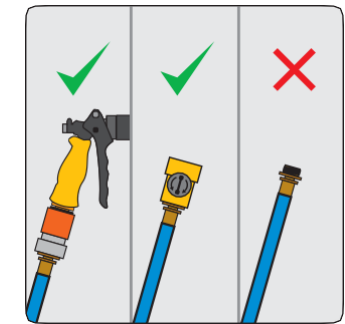

Attach either the **Watering Gun** or **Flow Restrictor** to the free end of the blue hose.

Initial Start-Up Operation

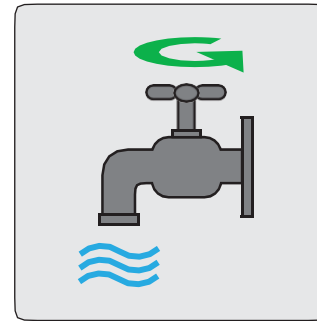

Turn on the mains water supply.

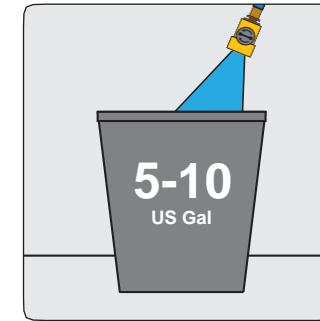

Pass 10 Litres (2.6 US Gallons) of water through the system into a bucket.

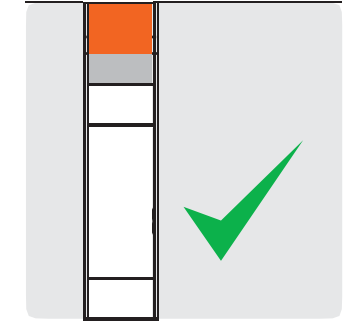

When the Purity Light turns green the system is ready for use.

Normal Operation

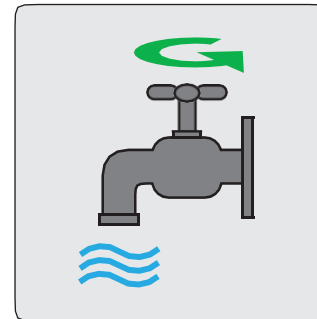

Turn on the mains water supply before use.

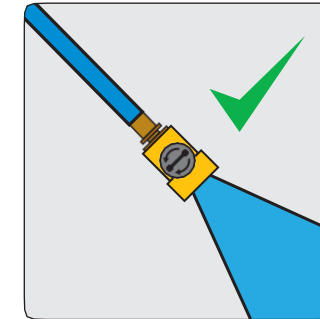

Ensure water is flowing through the system and use as required.

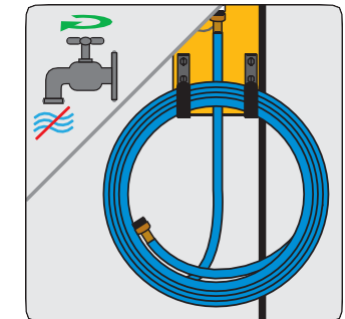

Once finished turn of the water supply and replace the hose on the hooks provided.