

SmartBlinky™

Screw (S)/Bolt (B)/FlexiTap (Q)



ACC-SWM3-S/B/Q/BD5/SD5



SWM3-S/B

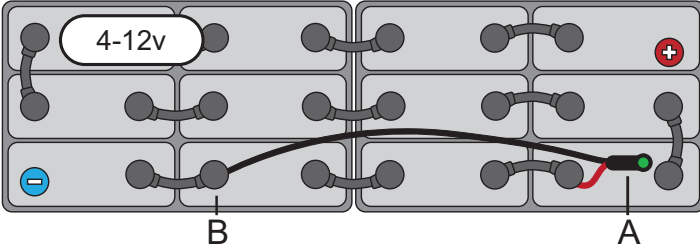

SWM3-Q

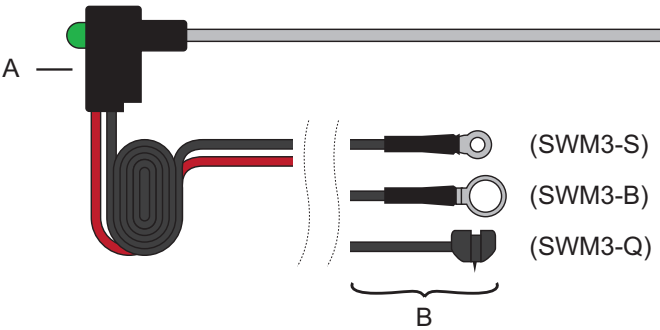
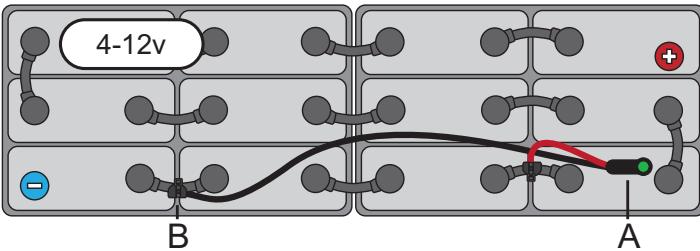

(SWM3-S)



x2

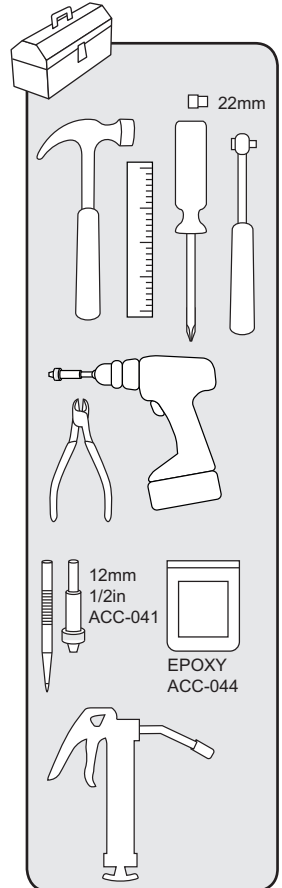

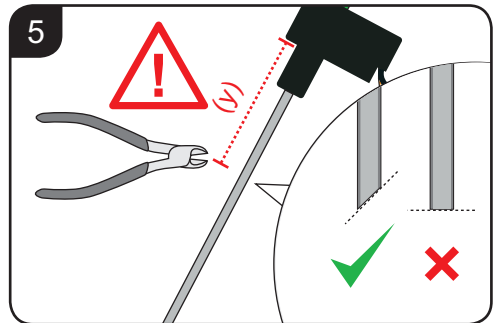
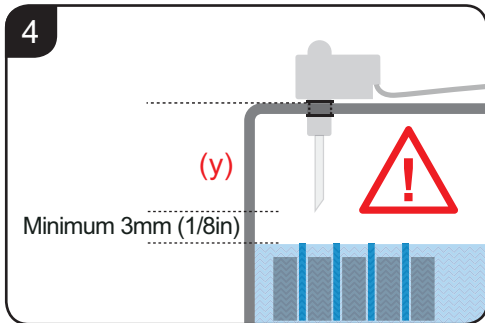
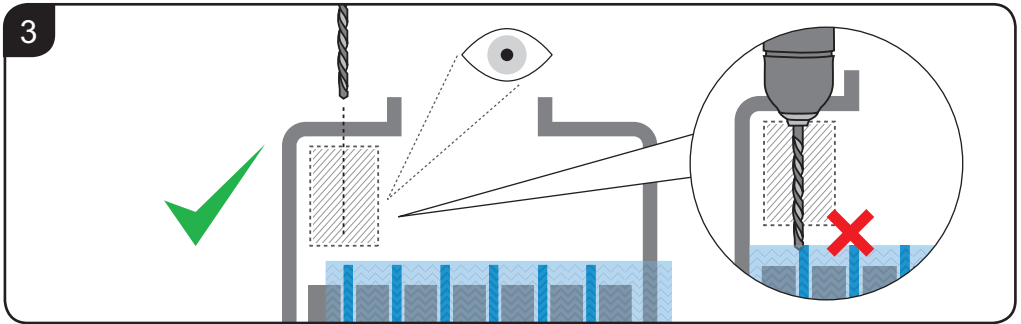
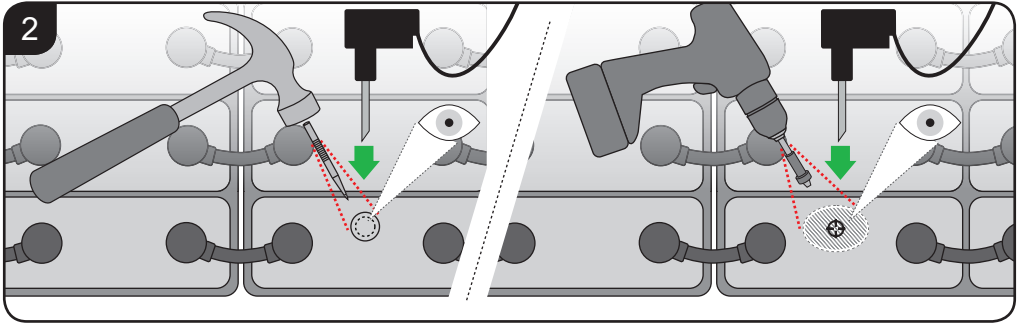
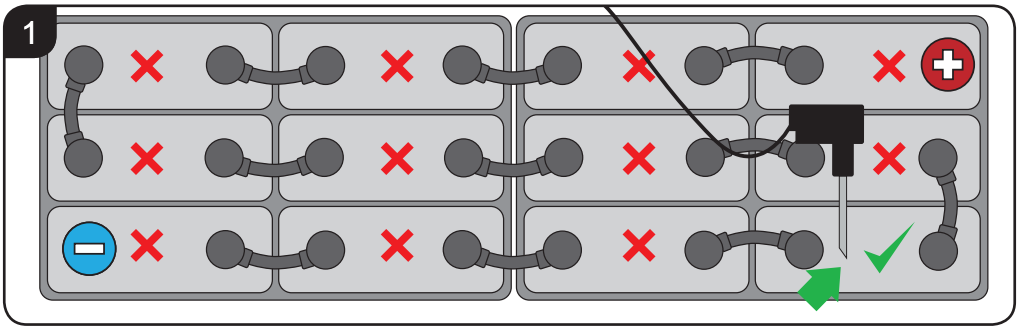

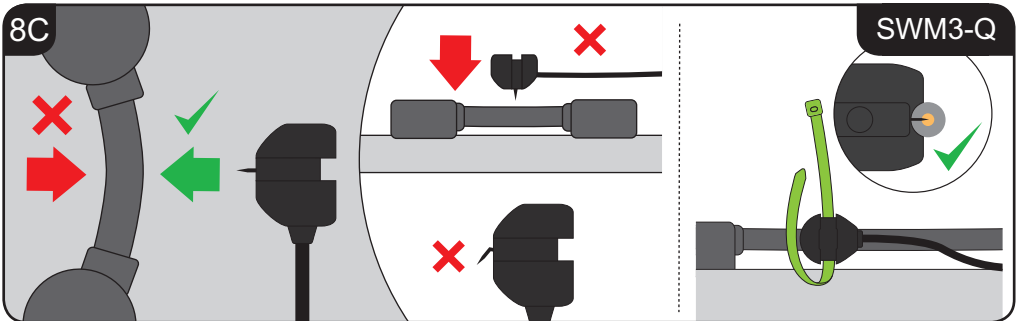
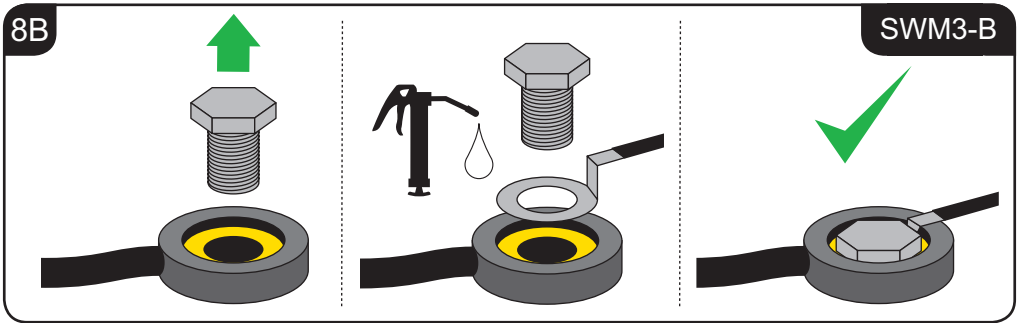
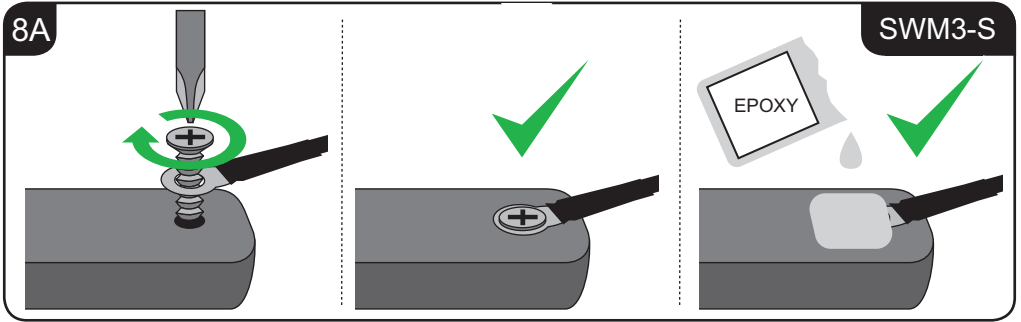
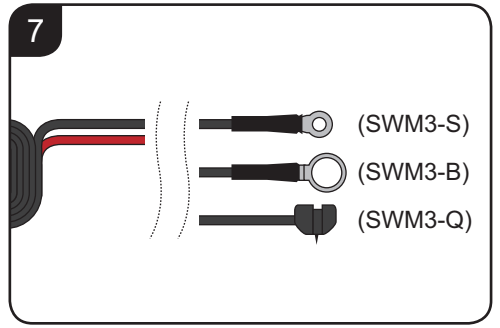
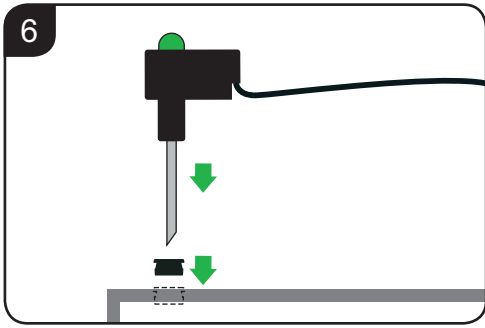

ACC-SWM3-S/B/Q

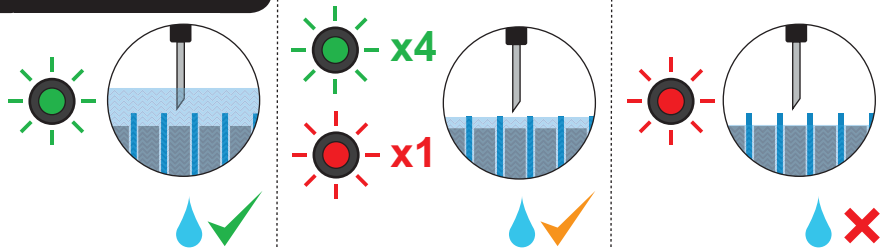

ACC-SWM3-BD5 / ACC-SWM3-SD5

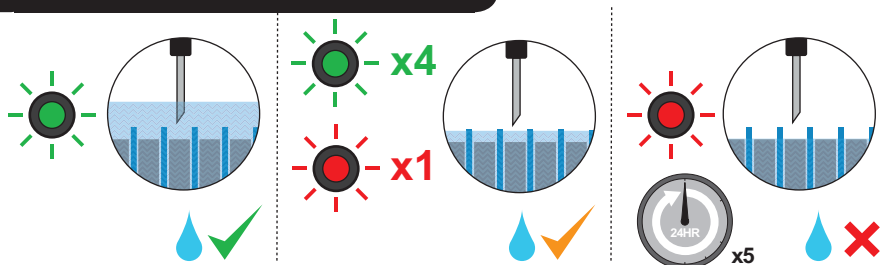

Monobloc

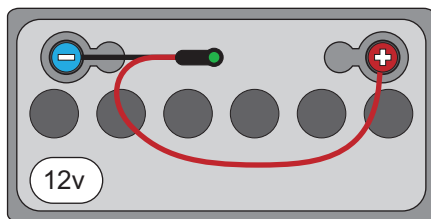
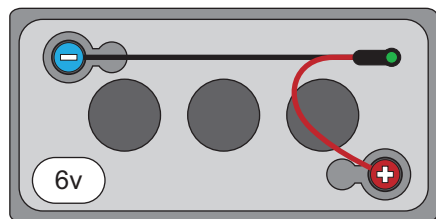

Americas: Info@phlsci.com
EMEA: info@ps-europe.net
Asia Pacific: info@phlsci.com.au
www.phlsci.com

Copyright © 2015 by Philadelphia Scientific LLC. All Rights Reserved. Philadelphia Scientific and the PS logo are registered trademarks of Philadelphia Scientific LLC. SmartBlinky is a trademark of Philadelphia Scientific LLC

DOC0075